

PRODUCT CATALOG

Architectural Elements



TABLE OF CONTENTS

Information

Hard Coat EPS System	04
Product Data Sheet	05-08

Ballusters	09
-------------------------	----

Brackets

Modern	10
Classic	11
Designer	12

Columns	13
----------------------	----

Column Caps	14
Column Bases	15

Corbels

Modern	16
Classic	17
Designer	18

Crown Molding

Modern	19
Classic	20
Designer	21

TABLE OF CONTENTS

Louvers

Modern	22
Classic	23
Designer	24

Medallions

Modern	25
Classic	26
Designer	27

Quatrefoils

Modern	28
Classic	29
Designer	30

Raftertails

Modern	31
Classic	32
Designer	33

Reliefs & Panels	34-35
-----------------------------	-------	-------

Rosettes	36
-----------------	-------	----

TABLE OF CONTENTS

Shutters

Modern	37
Classic	38
Designer	39

Trim	40
-------------------	----

Mailboxes	41
------------------------	----

Photos

Commercial Projects	42
Residential Projects	43

HARD-COATED EPS FOAM SYSTEM

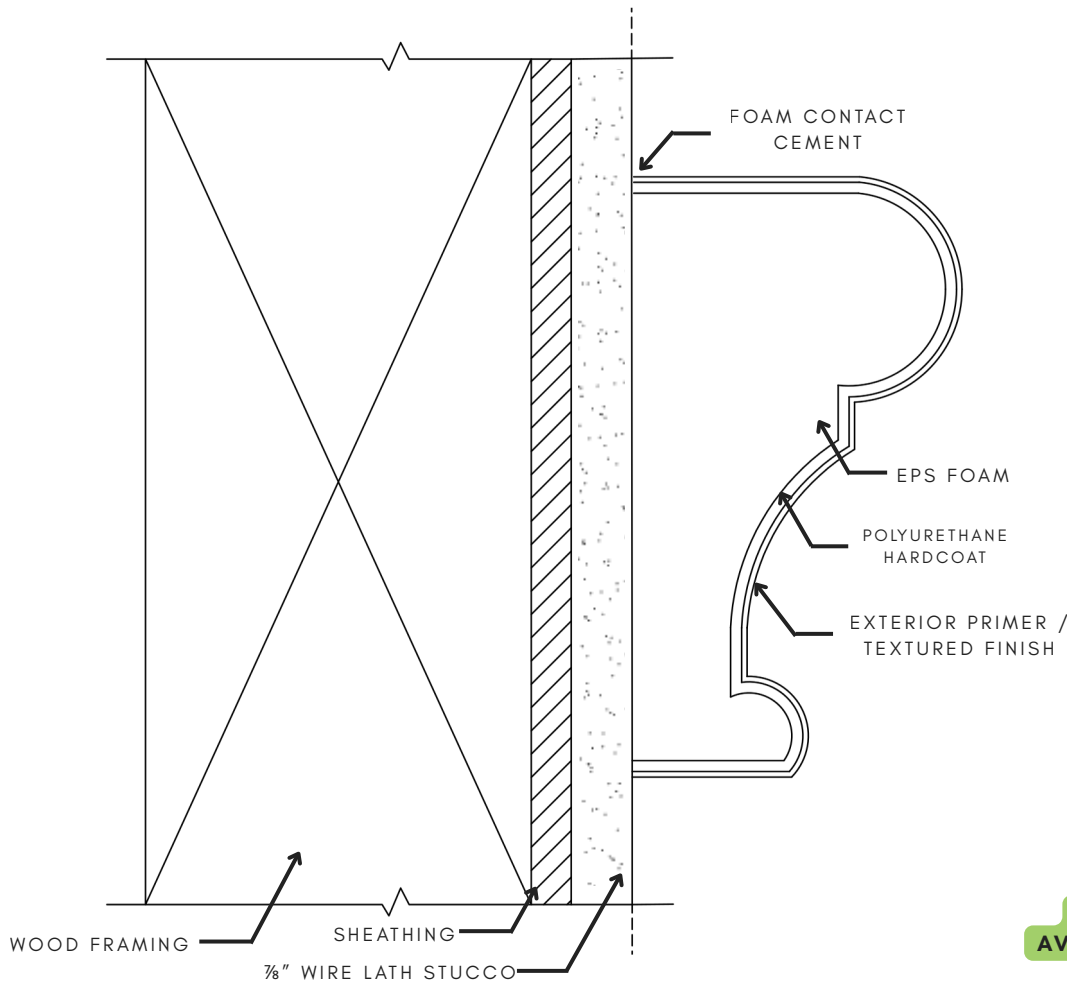
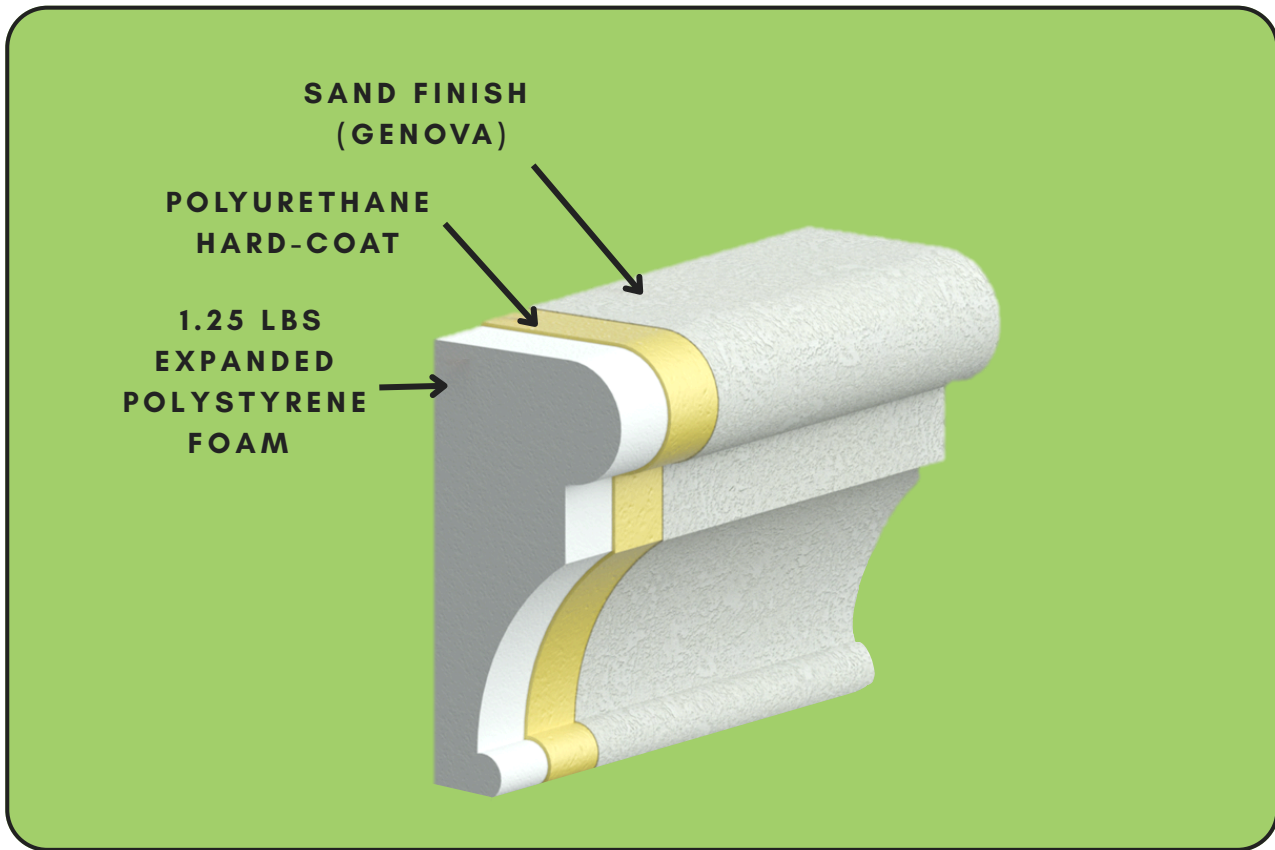

FINISHES



MEDIUM SAND



FINE SAND



PRIMER

OTHER FINISHES & FOAM DENSITY AVAILABLE PER CUSTOMER REQUEST



Using Expanded Polystyrene (EPS) foam as its material of choice, Foam King Designs provides cost-effective, competitive solutions to a variety of markets, notably the construction industry.

A leader in providing architectural foam – a lightweight, durable decorative element in both residential and commercial applications – Foam King Designs products can mimic the appearance of any element, for example, wood, stone or plaster. This provides the desired look of a design at a fraction of the weight and cost. Architecture foam products are resistant to moisture, suitable for both interior and exterior applications, and extremely light weight for ease of installation.



**Manufacturers of
Architectural Foam
Shapes & Cast Stone**

CONSTRUCTION INTEGRITY

Expanded Polystyrene (EPS) is a rigid, foamed plastic with resilient closed cells in a range of densities. The EPS product Foam King Designs typically uses is Carpenter’s 1.25 lb. block, manufactured to meet ASTM C578-95.

It complies with the flammability requirements of BOCA, ICBO, and SBCCI building codes; is approved for use under the current Miami-Dade County Building Code requirements as well as the recognized Florida Building Code approvals. (EPS construction products are classified in Division 7 of the Construction Specifications Institute.) It’s strength, rigidity, and low density meets ASTM D6817 “Standard Specification for Rigid, Cellular Polystyrene Geofoam.”

The current industry standard for sealing and protecting Expanded Polystyrene shapes is to first create an ultra-hard shell, followed by a durable, weather-resistant coating. At Foam King Designs,

a two-part polyurethane resin manufactured by Urethane Technology Company is first applied. The product was developed for applications wherever a tough monolithic membrane is required. This hard urethane shell known as the hardcoat, is highly durable with impact and moisture resistance.

Once the hardcoat is dry, an acrylic polymer finish is applied. The coating used in this process is one of Decoplast's weather resistant barrier finishes. Custom colors and custom matches are available. Designed for exterior use, Decoplast's finishes withstand thermal expansion and contraction without delamination.

NOTE: The hard-coat and/or finish selected may result in a minor variability in product dimensions, usually within a 1/8th inch margin.

DESIGN INTEGRITY

Due to the variable nature of producing custom designs, many dimensional requirements accurately specifying the end product are gathered prior to the creation of a digitized, 3D technical drawing. Whenever possible, submit blueprint drawings.

For example, see the profiles in Diagram 1 (right). In addition to length, width, and depth, required measurements include all specifics that define each design feature: the length of the footing, the size of each concave ring, the length of the leg, etc. The more curves or planes to a profile, the more measurements are required.

Manufacturing various architectural profiles in foam is probably the most cost-effective way there is in today's market to add this feature to a home or commercial project.

If you need your columns made of a stronger material, Foam King Designs also has precast capabilities.

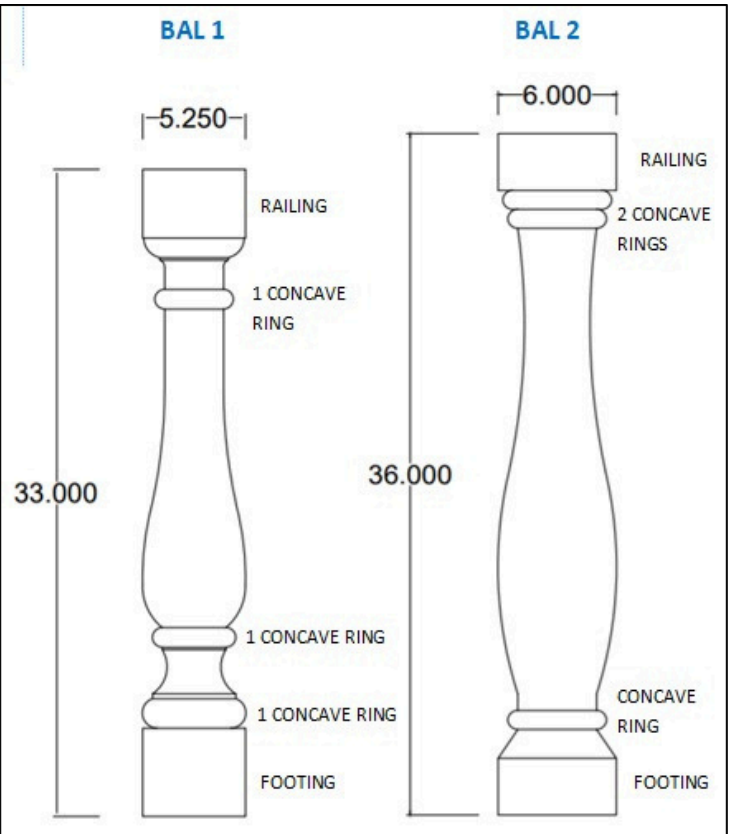

Diagram 1

COLLABORATION

There are occasions when installation may not meet blueprint specifications. An example of this is when a bracket cannot be mounted flush to the building for some reason, though the design called for a mounted bracket. The fabrication team can adjust the bracket dimension by adjusting the design.



Sample bracket

In this case, in addition to the height, length, and width of the bracket, include the height and width of the plates.

The AutoCAD file is finalized only with customer signature approval, indicating that it accurately represents the desired result.

NOTE: A hot wire CNC cutter reproduces the foam profile in correct proportion to the dimensions specified, within $\pm .002$ "/foot.

FINISHING TOUCHES

While EPS block size-limitations dictate one-piece length capabilities, Tytan Foam Bond 60 is used to fasten raw foam pieces together to meet an architect's design. The bond contains no solvents, making it EPS foam safe. Bonding substrates occurs within seconds and it is secure within five minutes of application. Within 24-hours the profile is ready for coating.



8' x 6' x 5' FOAM BLOCKS



Foam King Designs uses a highly productive, powerful design and drafting software program that draws at a real world scale (1:1).

4 AXIS ROUTER



3 AXIS HOT WIRE



CUSTOMER SERVICE

In addition to contacting our team at Foam King Designs check out our website. In addition to showcasing samples of our work, standard profiles are available for order.

Let us quote your next job! PHONE: 321-401-5151



Scan for more info.



FOAM



PRECAST



decoplast



- Adhesives & Bonding Agents
- Weather Resistant Barriers
- Basecoats
- Fiberglass Reinforcing Meshes & Flashing Fabrics
- Decolath
- Coatings
- Speciality Finishes

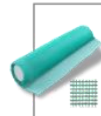

Ask about our shipping options!

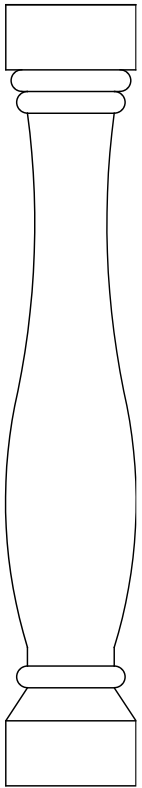

BA2000

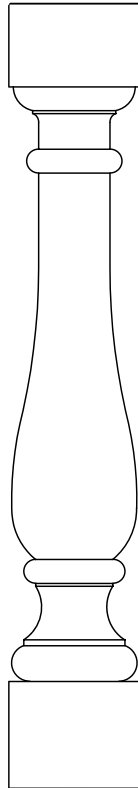

BA2001

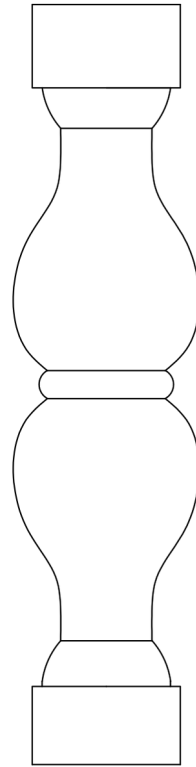

BA2002

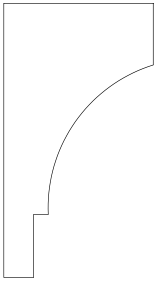

CB2020

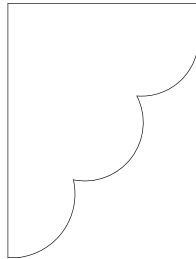

CB2022

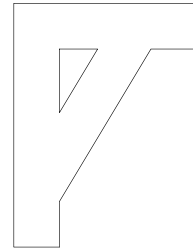

CB2023

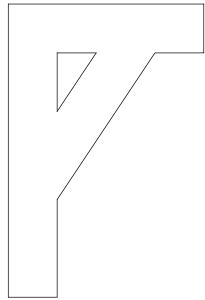

CB2011

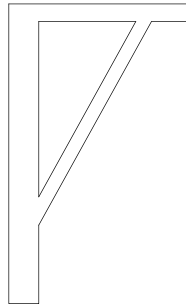

CB2016

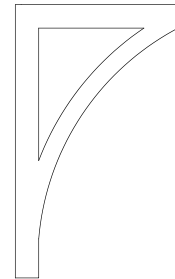

CB2030

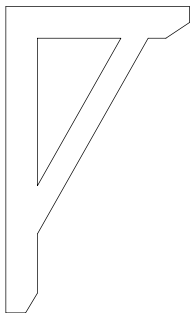

CB2031

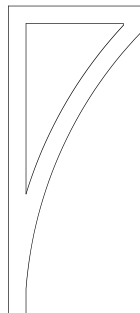

CB2024

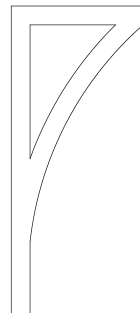

CB2028

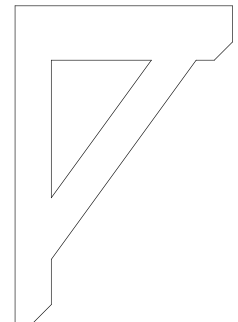

CB2025

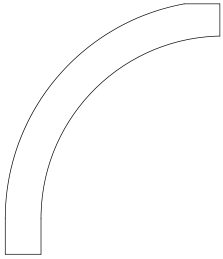

CB2014

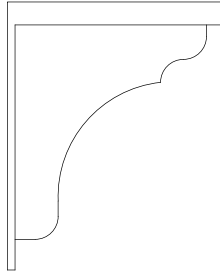

CB2007

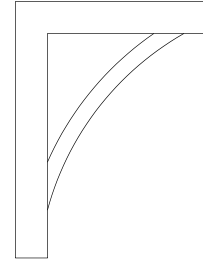

CB2029

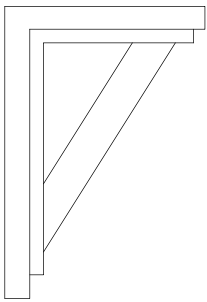

CB2015

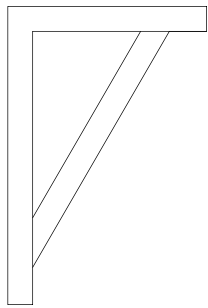

CB2019

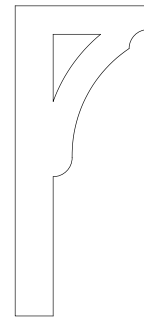

CB2010

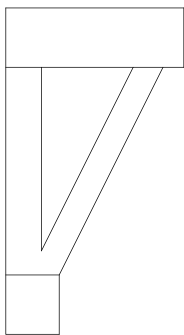

CB2026

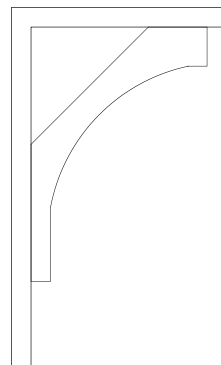

CB2018

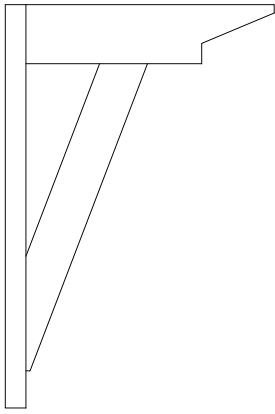

CB2027

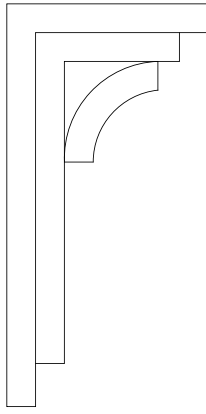

CB2009

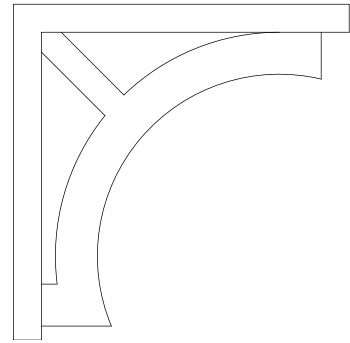

CB2008

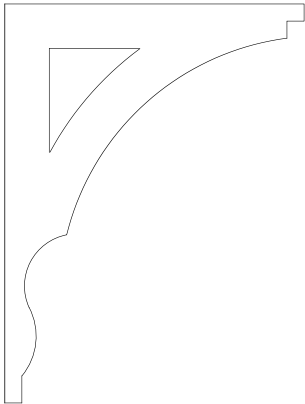

CB2013

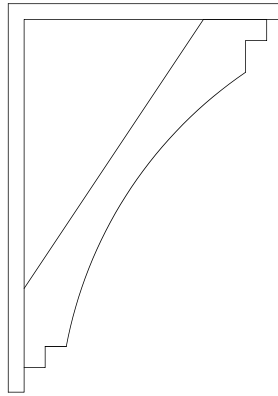

CB2021

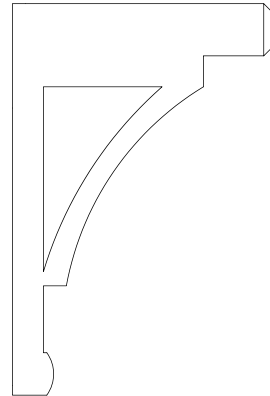

CB2017

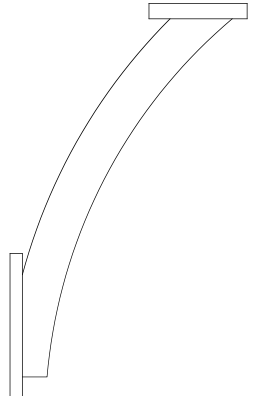

CB2012

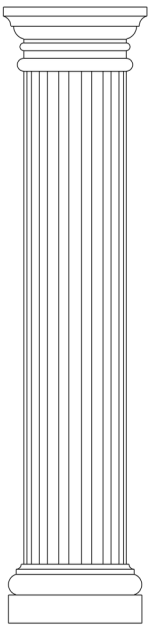

Fluted

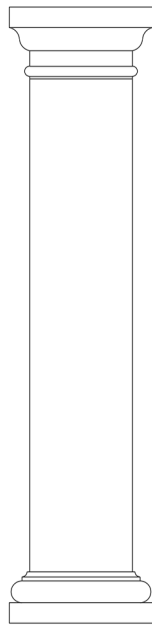

Tuscan

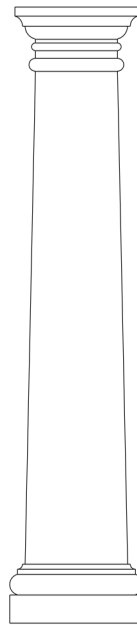

Tapered

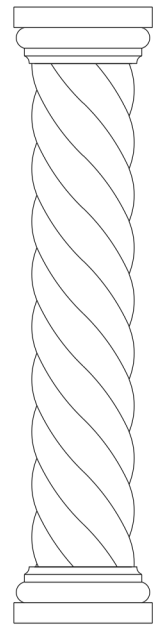

Rope

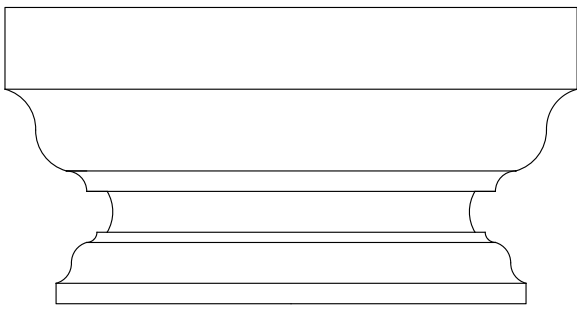

CP3000

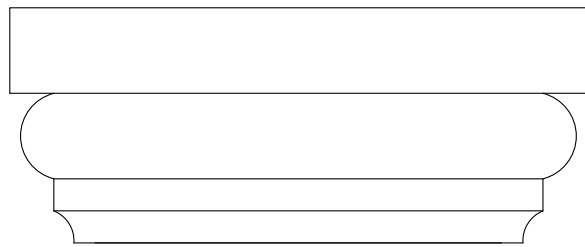

CP3001

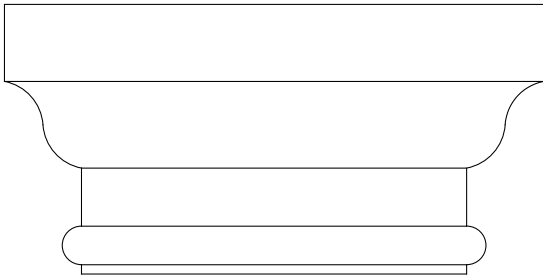

CP3002

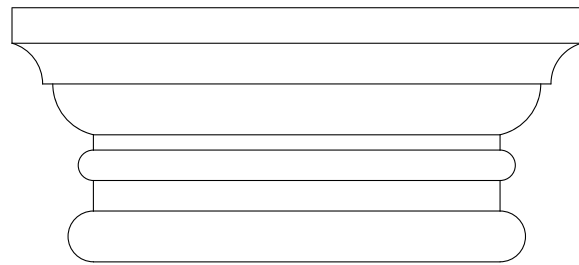

CP3003

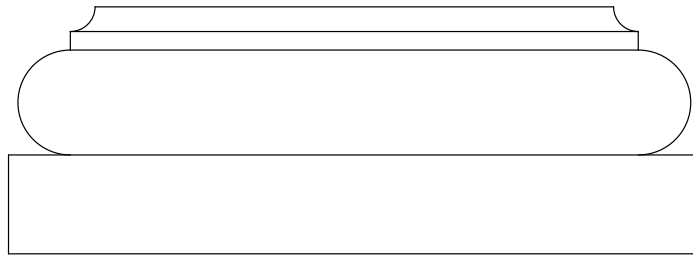

BE2000

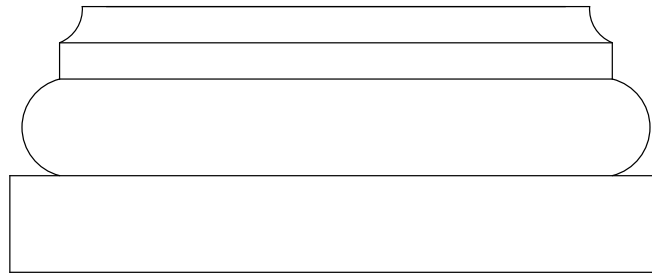

BE2001

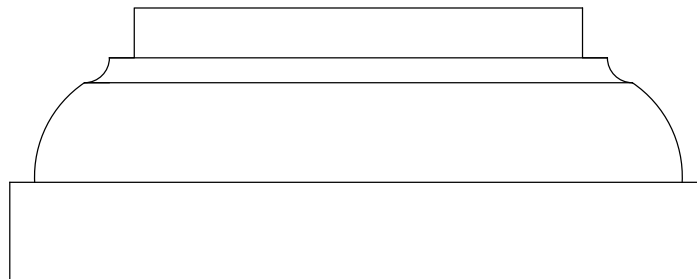

BE2002

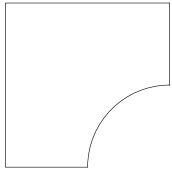

CB1002

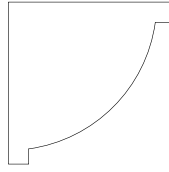

CB1003

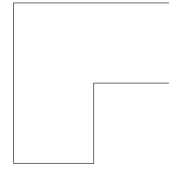

CB1004

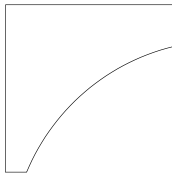

CB1005

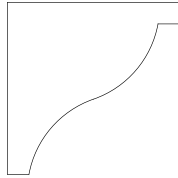

CB1006

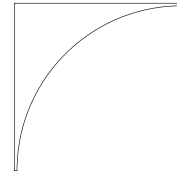

CB1008

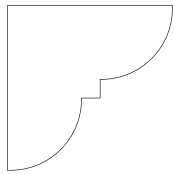

CB1009

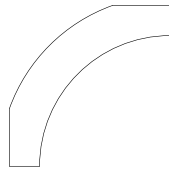

CB1011

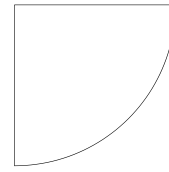

CB1012

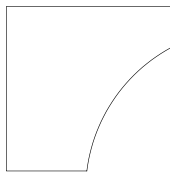

CB1014

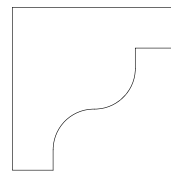

CB1015

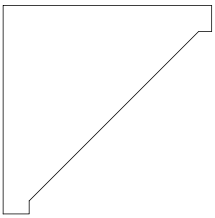

CB1007

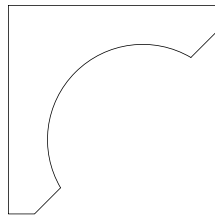

CB1010

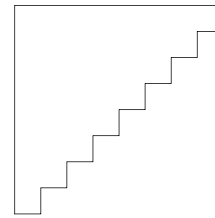

CB1013

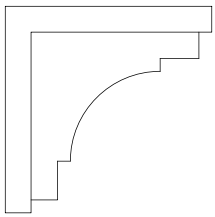

CB1016

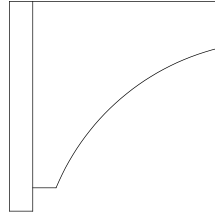

CB1017

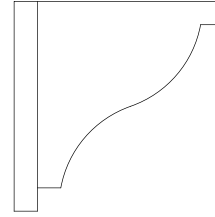

CB1018

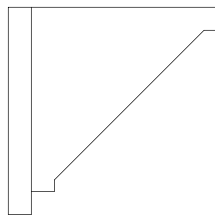

CB1019

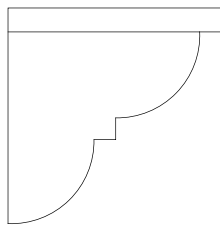

CB1021

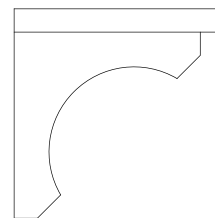

CB1022

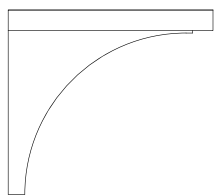

CB1020

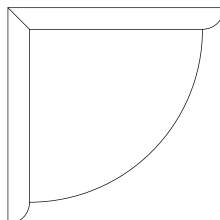

CB1024

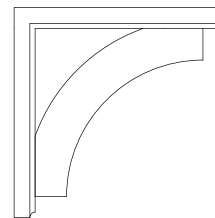

CB1023

Corbels

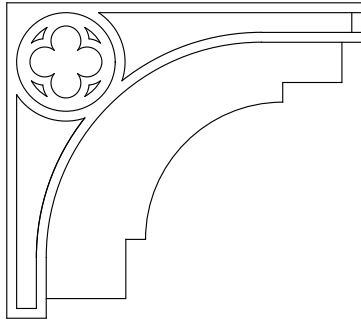

CB1028

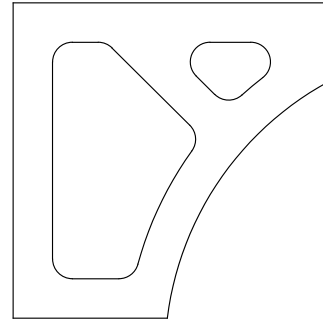

CB1026

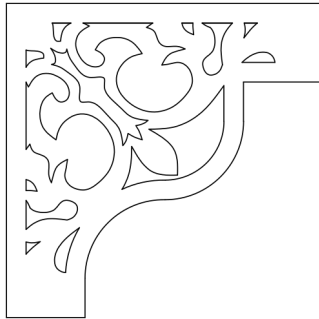

CB1027

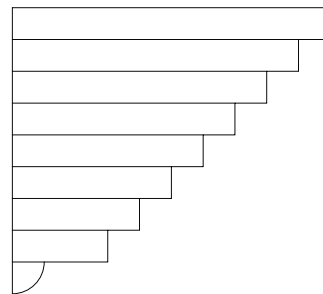

CB1025

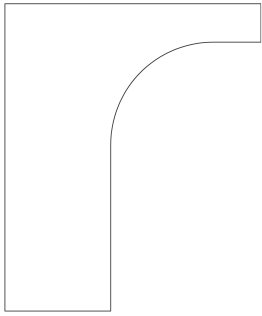

CM1000

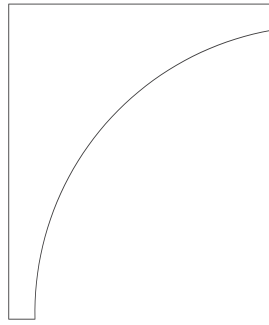

CM1001

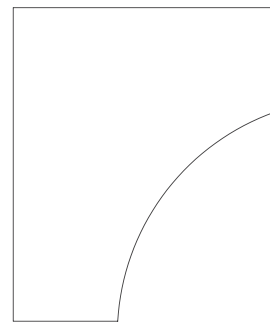

CM1002

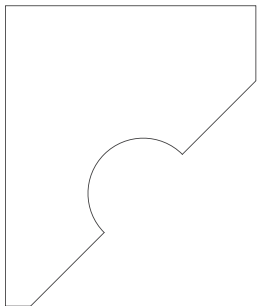

CM1003

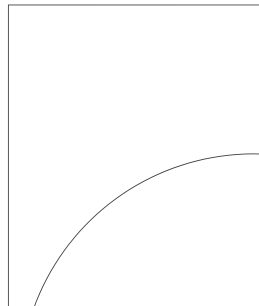

CM1004

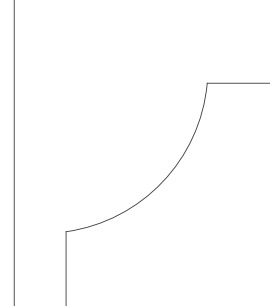

CM4001

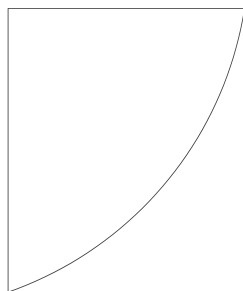

CM4004

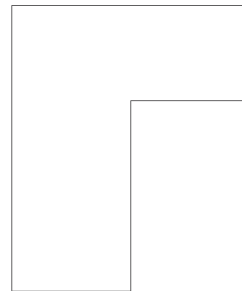

CM3000

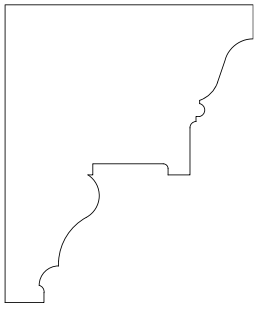

CM3001

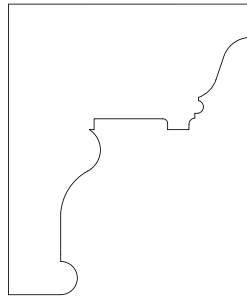

CM3002

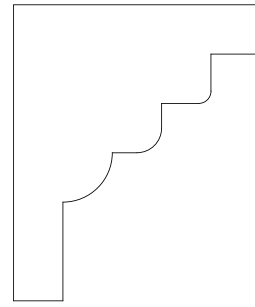

CM3003

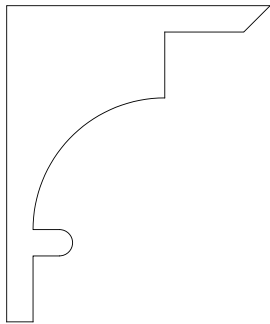

CM3004

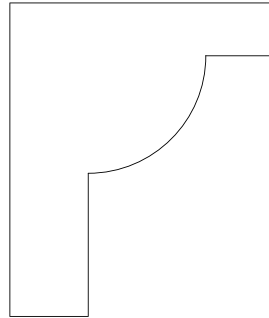

CM4002

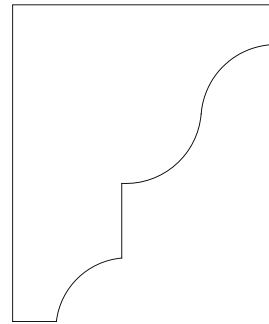

CM4003

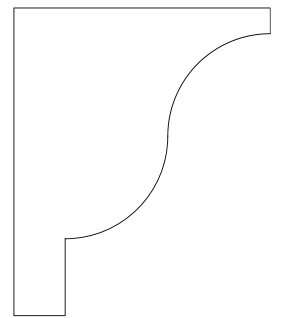

CM4005

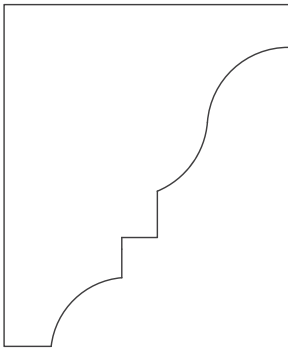

CM2000

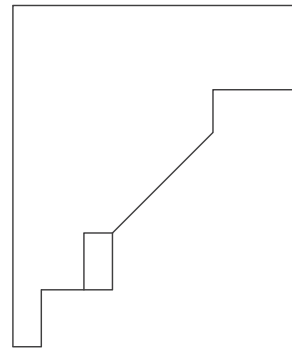

CM2001

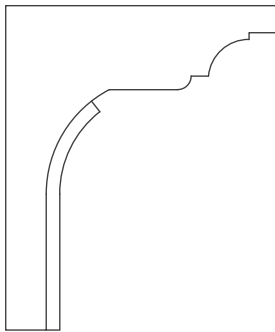

CM2002

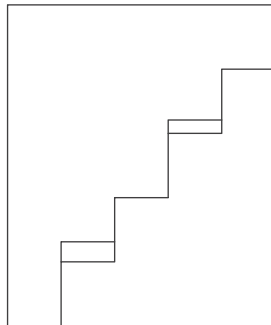

CM2003

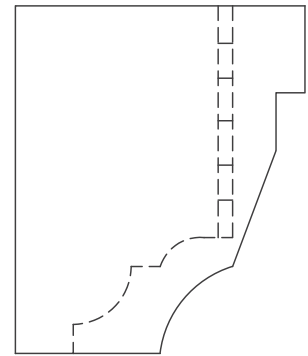

CM2004

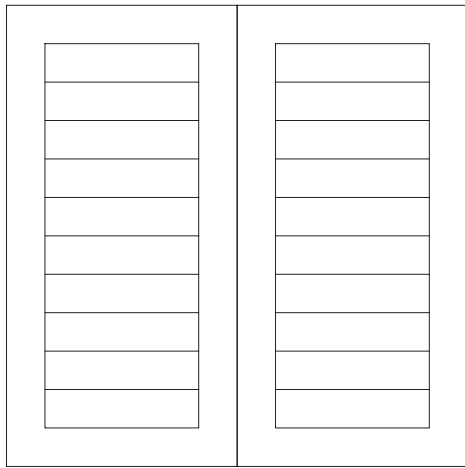

LV2000

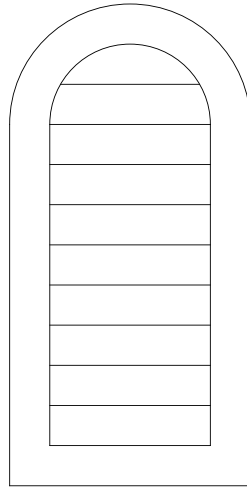

LV1001

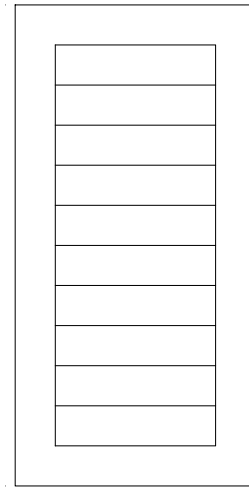

LV5000

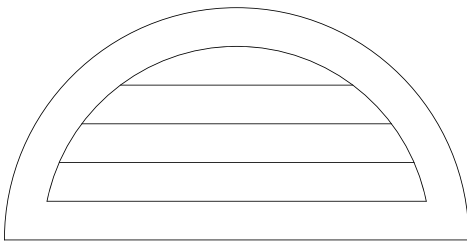

LV4001

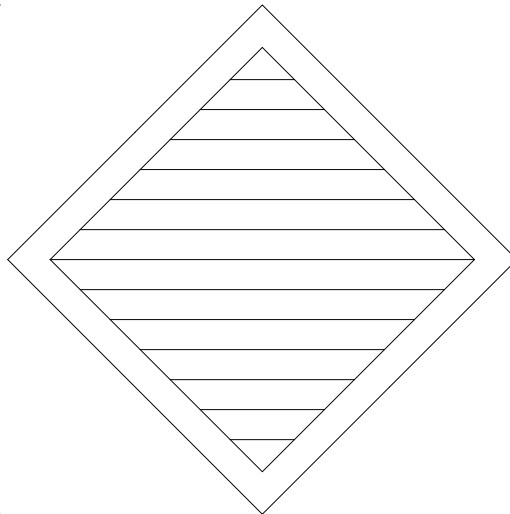

LV2001

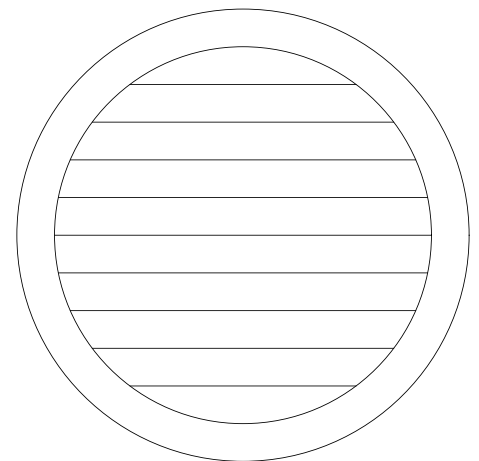

LV3002

Louvers

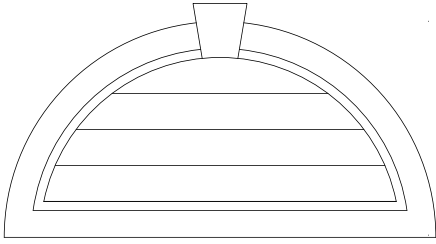

LV4002

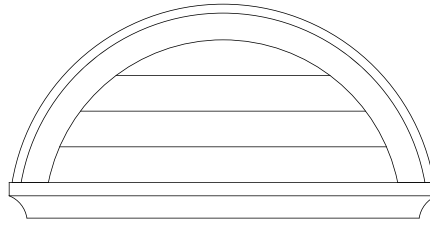

LV4003

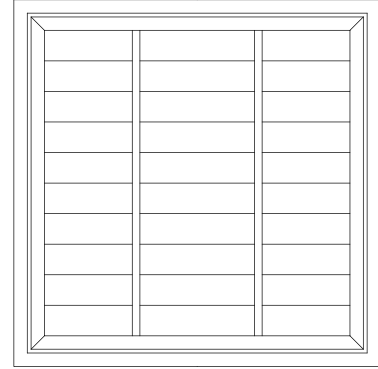

LV2002

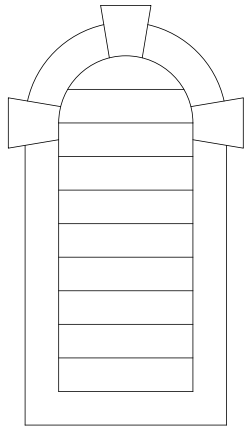

LV1002

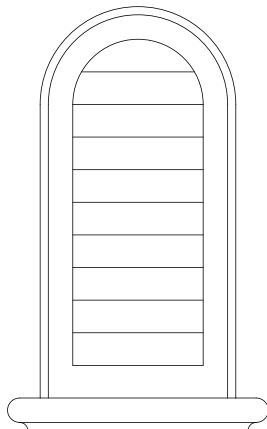

LV1003

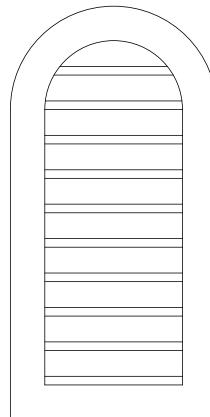

LV1004

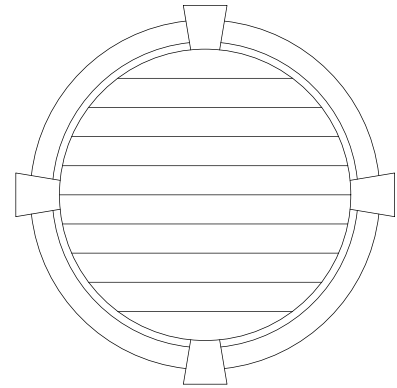

LV3003

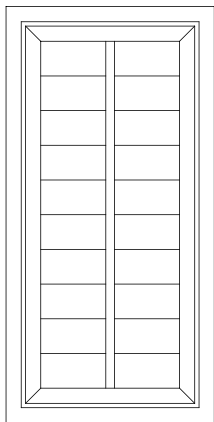

LV5002

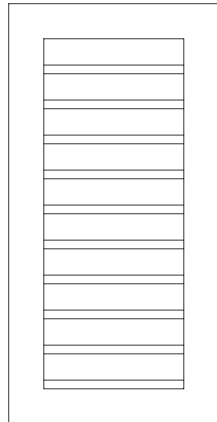

LV5004

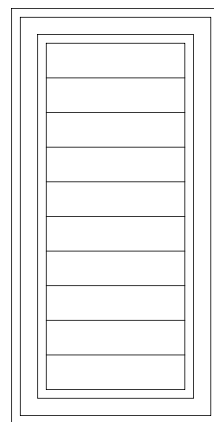

LV5001

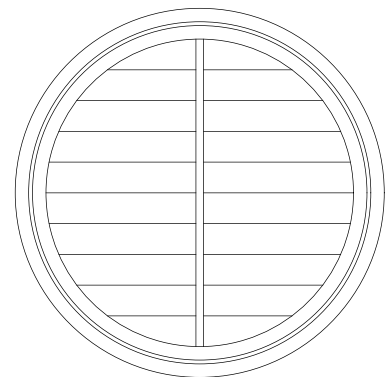

LV3004

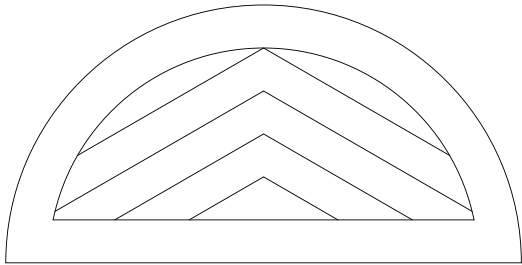

LV4000

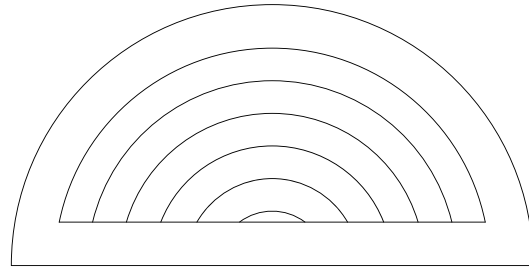

LV4004

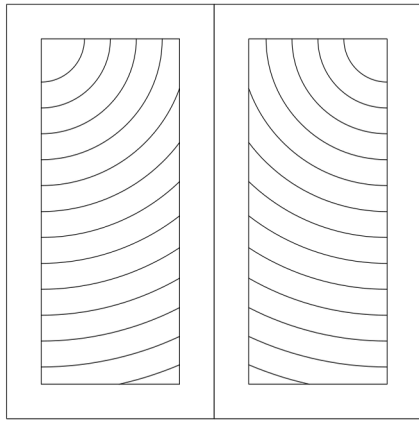

LV2003

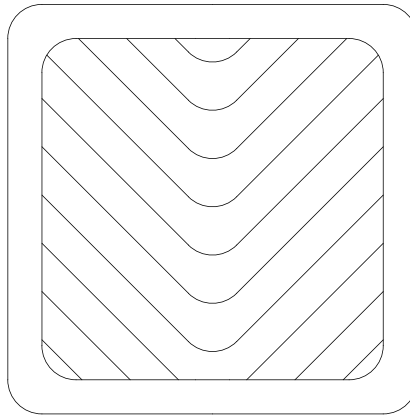

LV2004

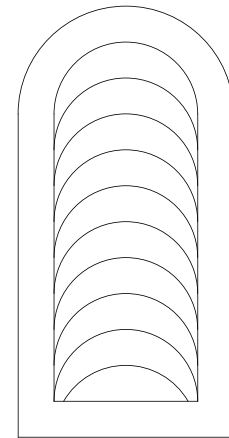

LV1005

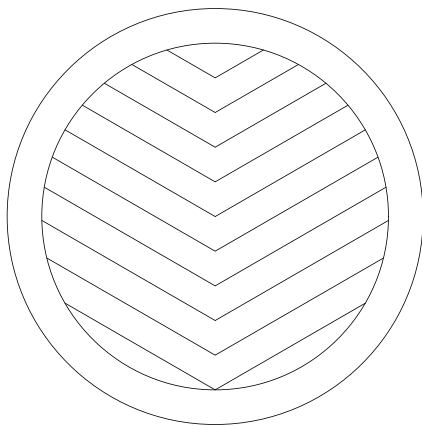

LV3006

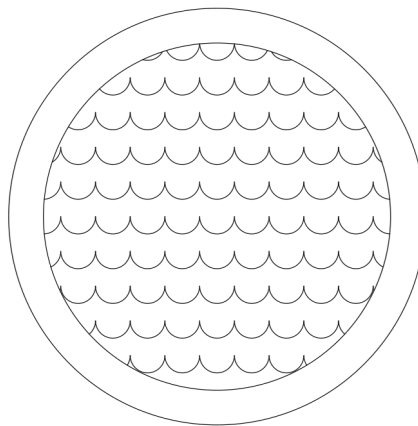

LV3005

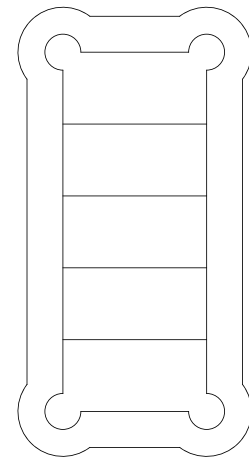

LV5003

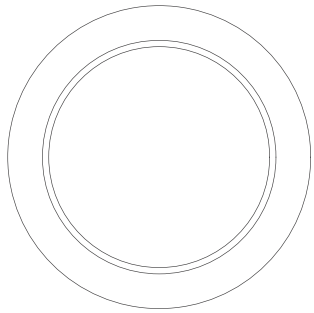

MD1000

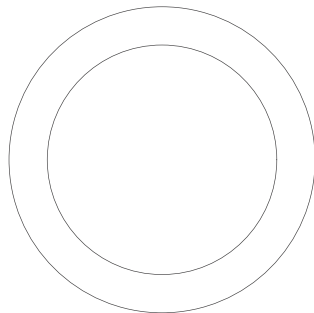

MD1001

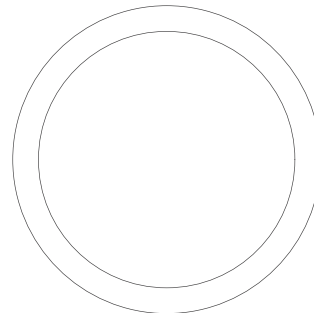

MD1002

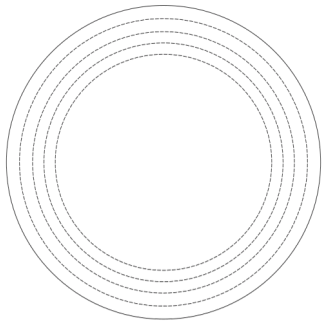

MD1003

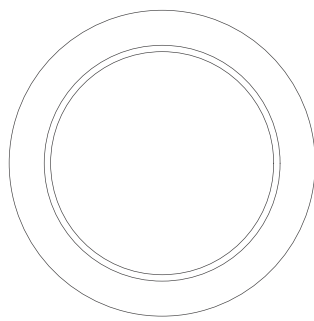

MD1004

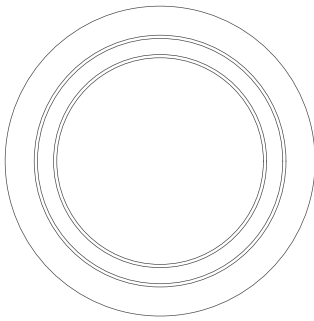

MD1005

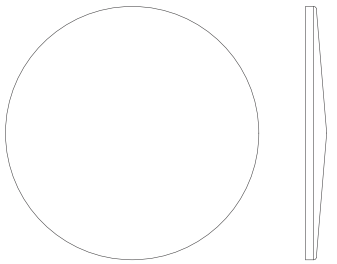

MD1015

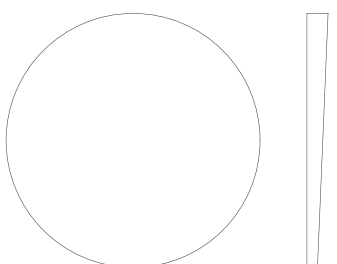

MD1016

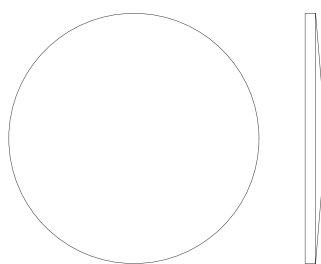

MD1017

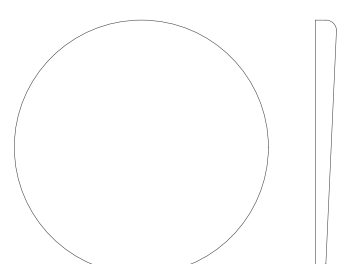

MD1018

Medallions

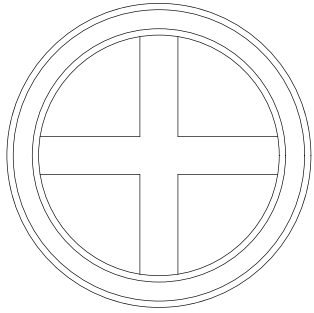

MD1006

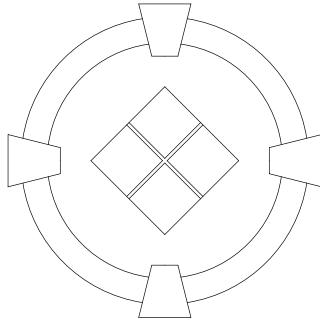

MD1007

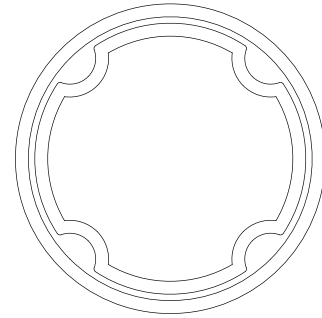

MD1008

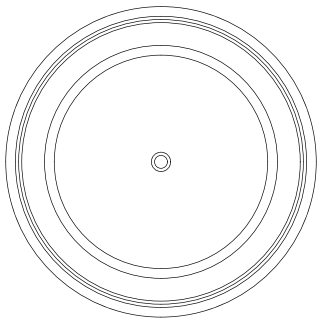

MD1009

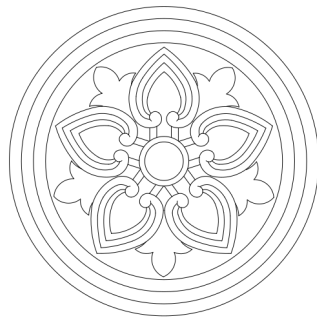

MD1010

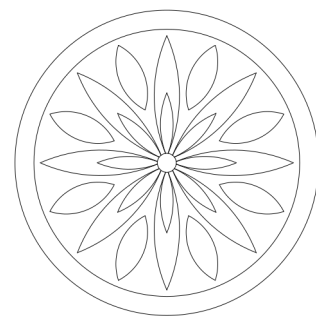

MD1011

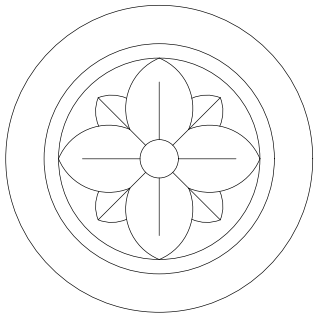

MD1012

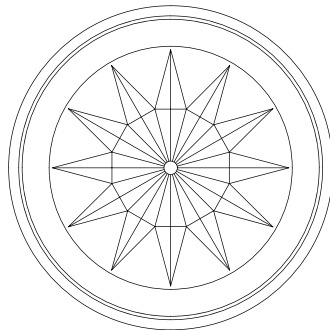

MD1013

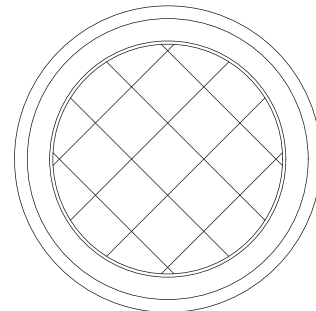
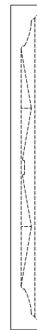

MD1014



Medallions

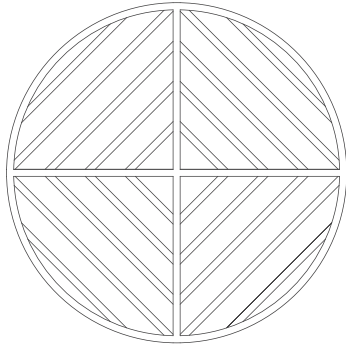

MD1019

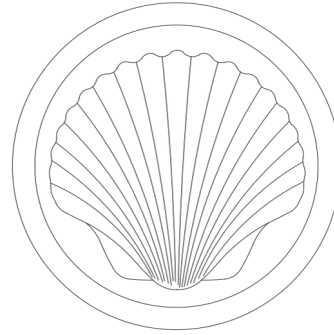

MD1022



MD1020

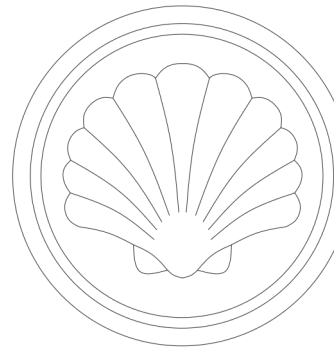

MD1023

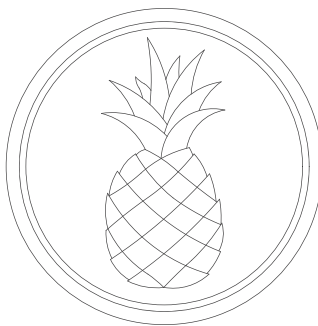

MD1021



MD1024



Quatrefoils

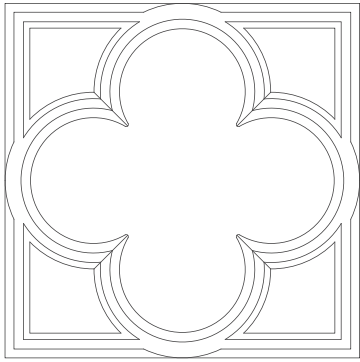

QF1004

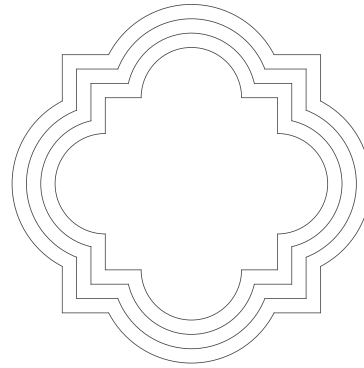

QF1005

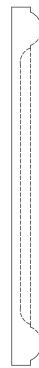
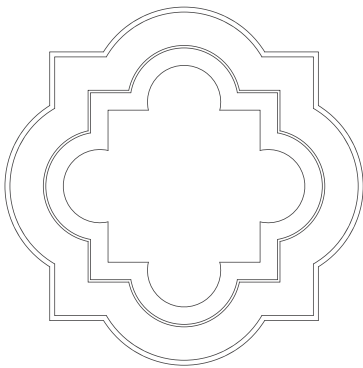

QF1006

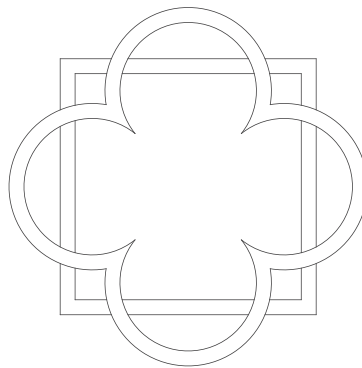

QF1015

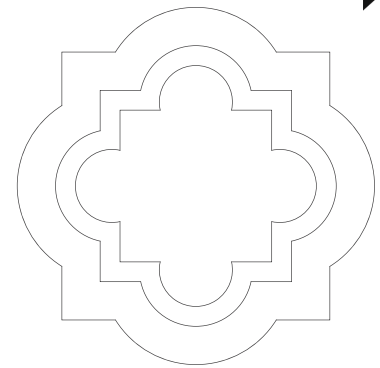

QF1018

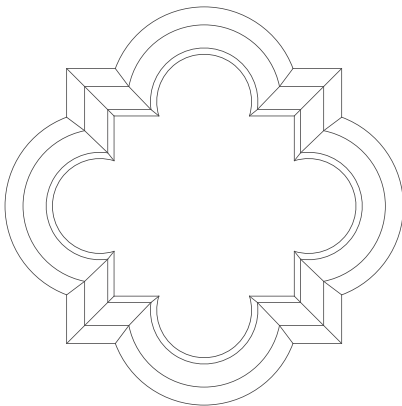

QF1019

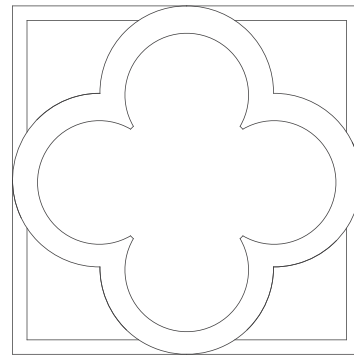

QF1021

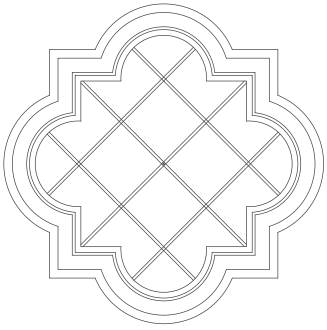

QF1002

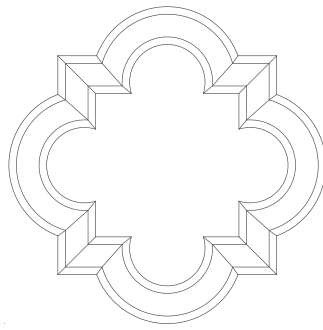

QF1011

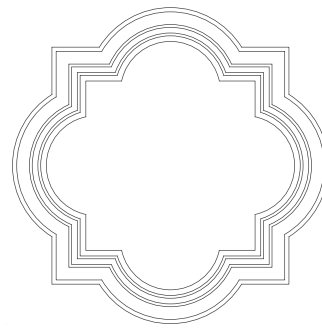

QF1012

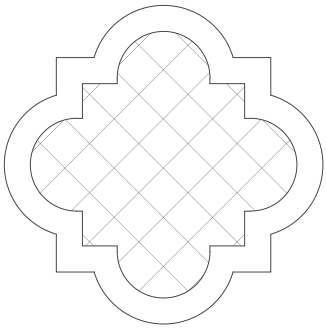

QF1020

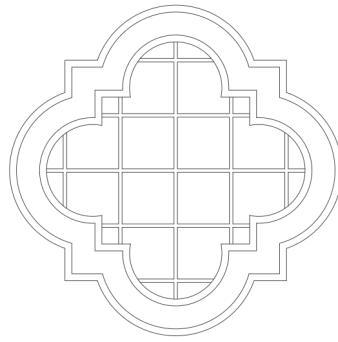

QF1022

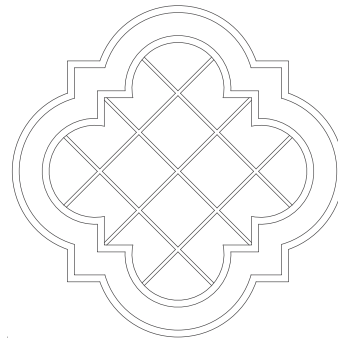

QF1023

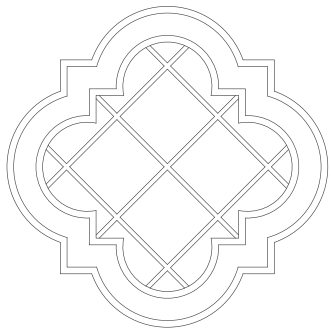

QF1024

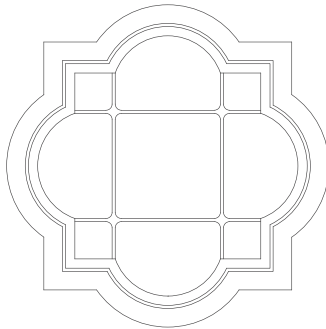

QF1025

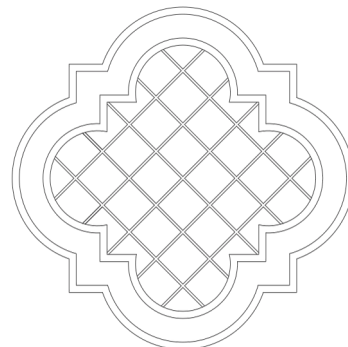

QF1026

Quatrefoils

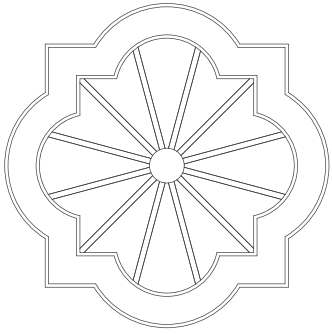

QF1003

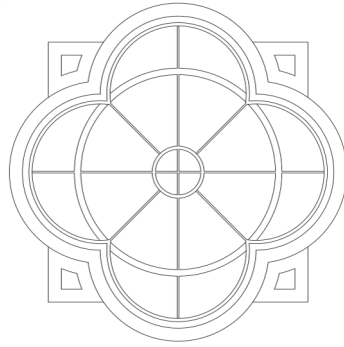

QF1007

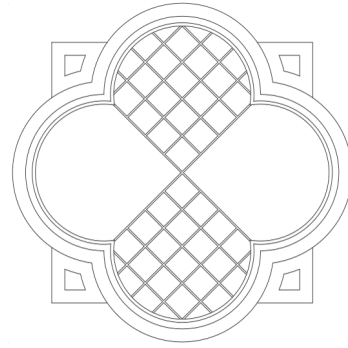

QF1008

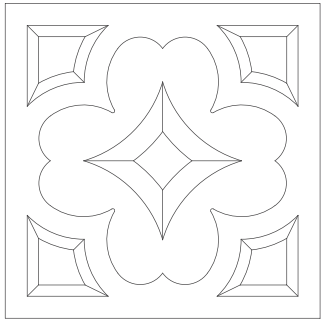

QF1009

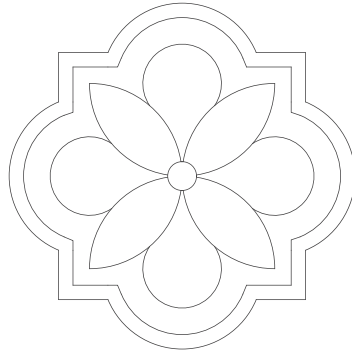

QF1010

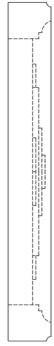
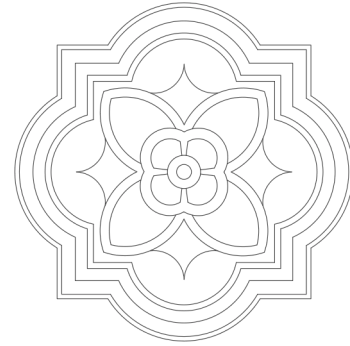

QF1013

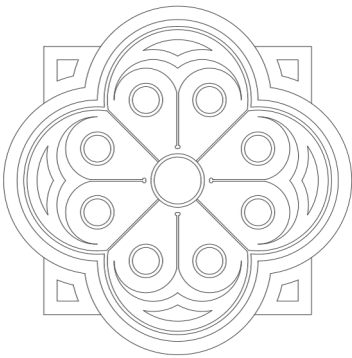

QF1014

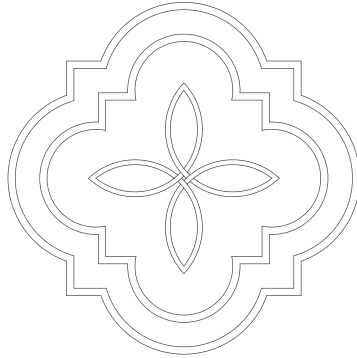

QF1016

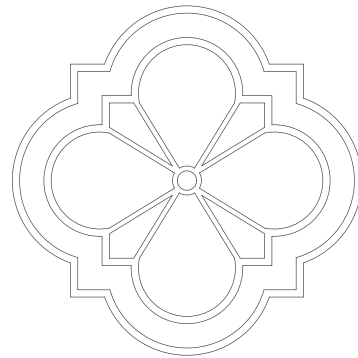

QF1017



CB3000

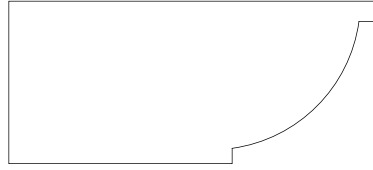

CB3001

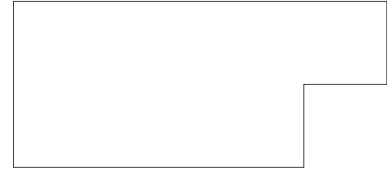

CB3002

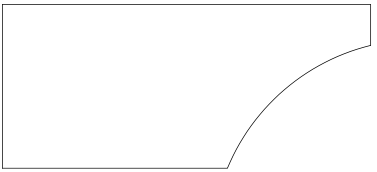

CB3003

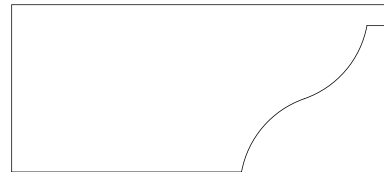

CB3004

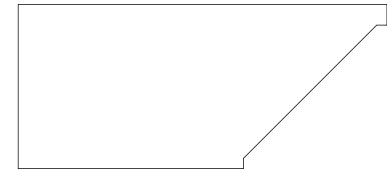

CB3005

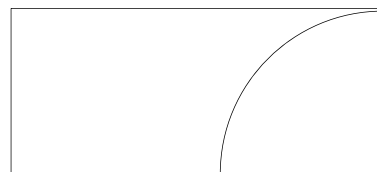

CB3006

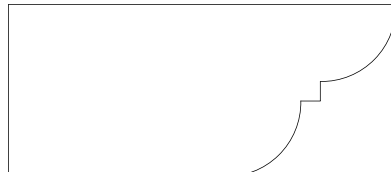

CB3007

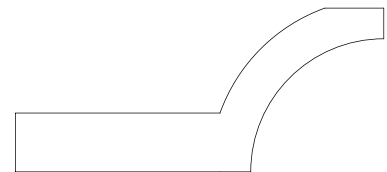

CB3009

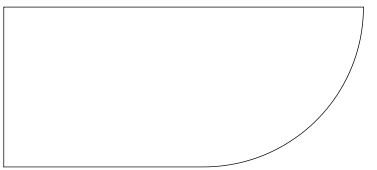

CB3010



CB3012

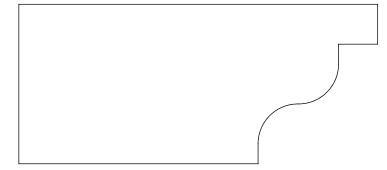

CB3013

RafterTails

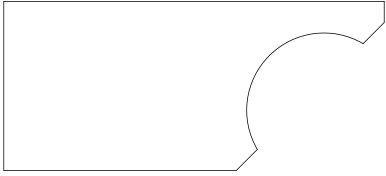

CB3008

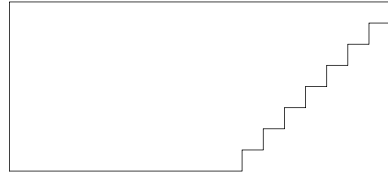

CB3011

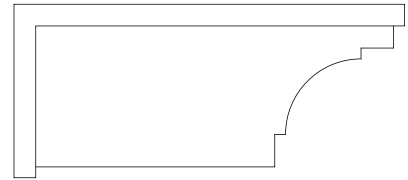

CB3014

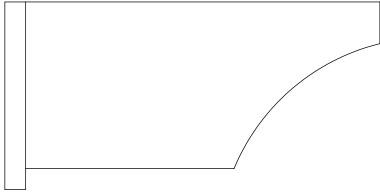

CB3015

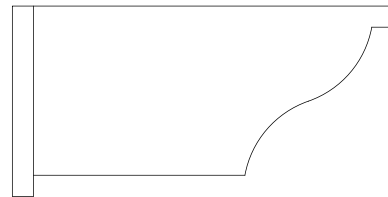

CB3016

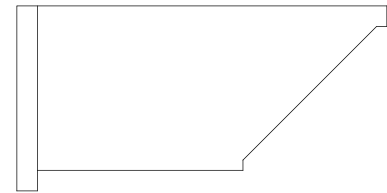

CB3017

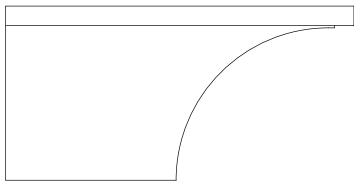

CB3018

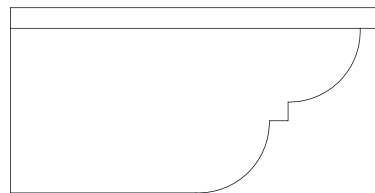

CB3019

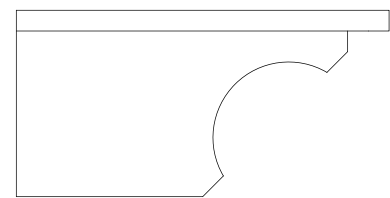

CB3020

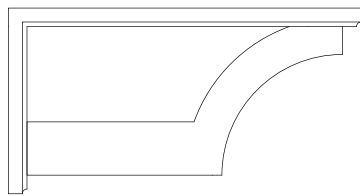

CB3021

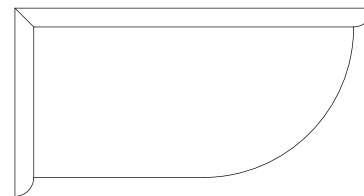

CB3022

RafterTails

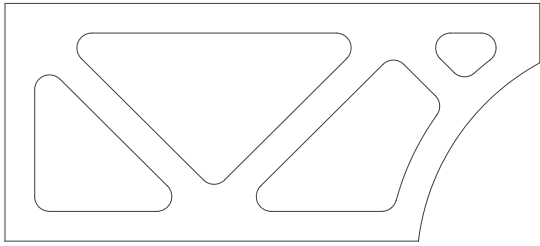

CB3024

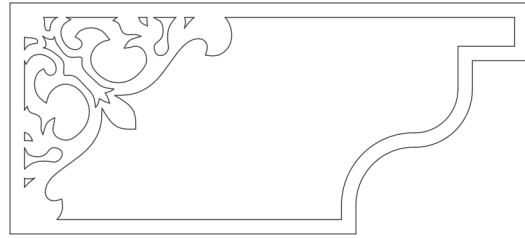

CB3025

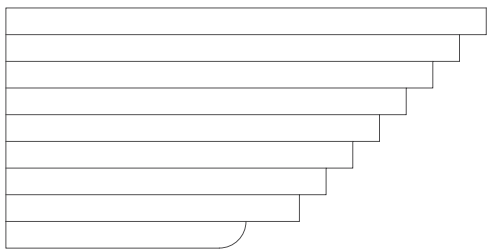

CB3023

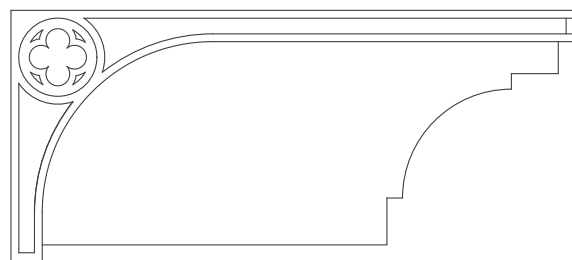

CB3026

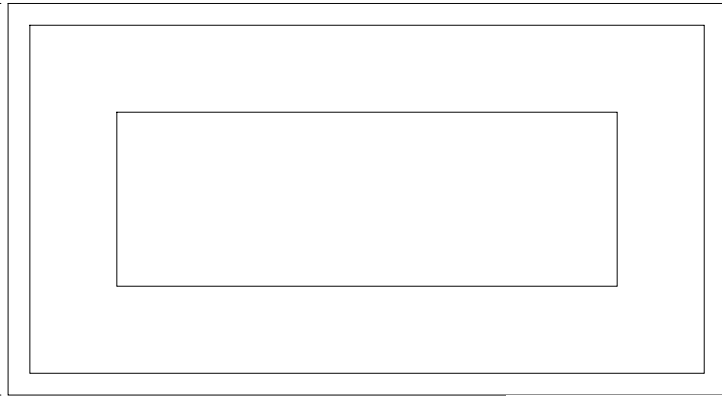

PA1005

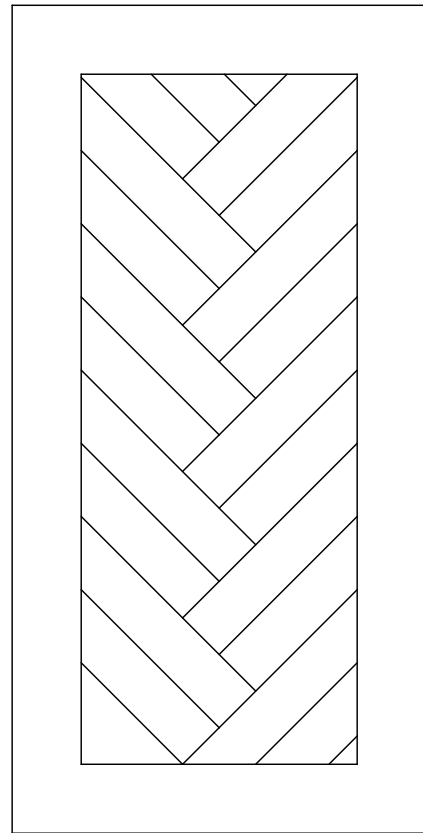

PA1008

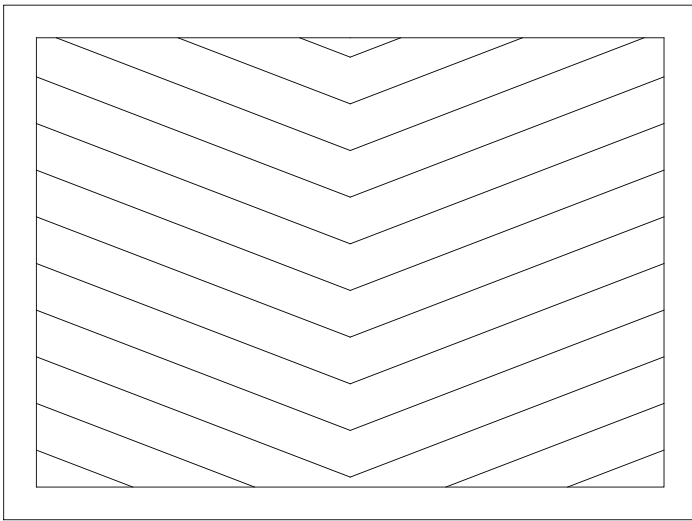

PA1006

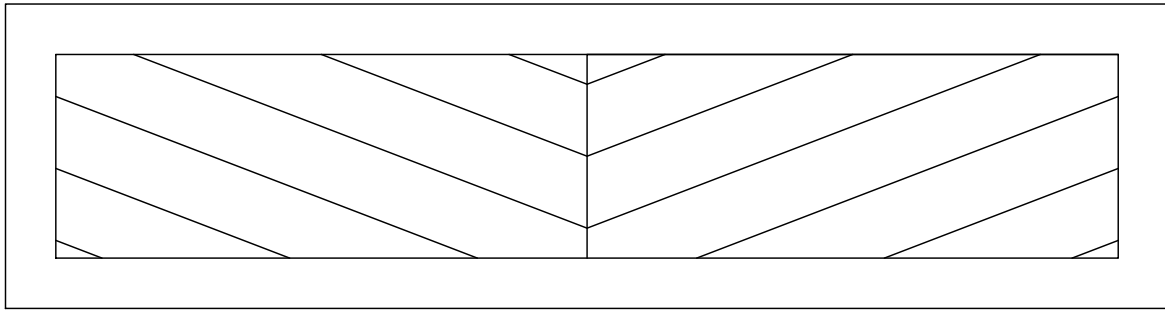

PA1007

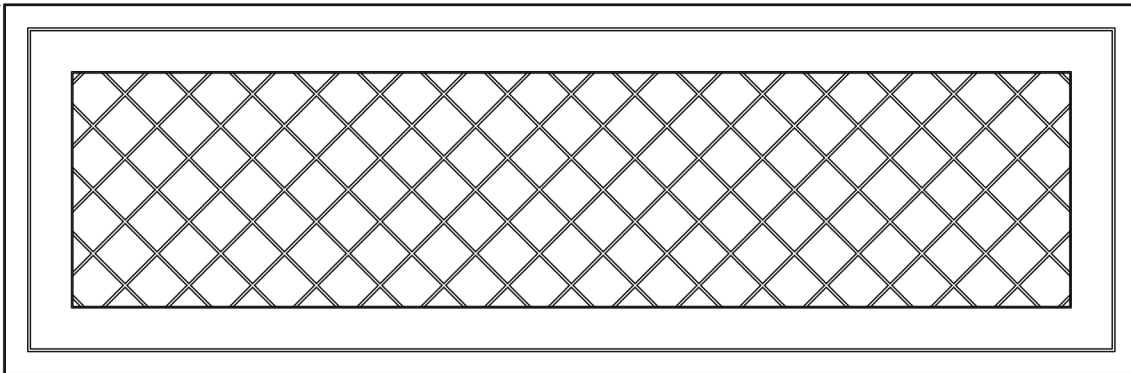

PA1004

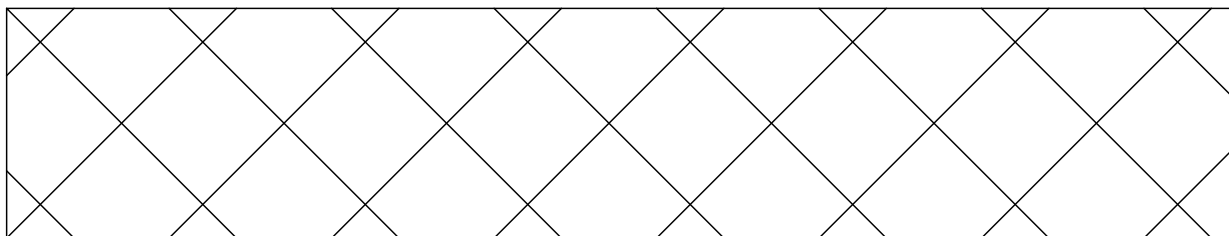

PA1003

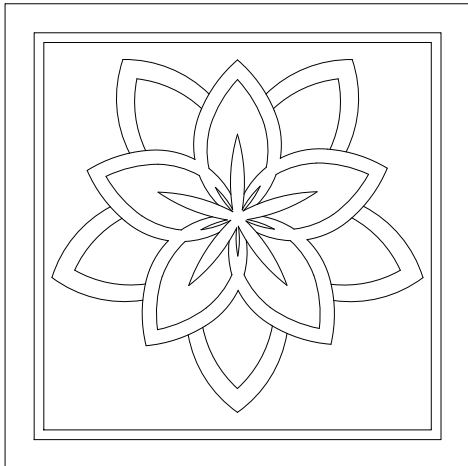

RE5000

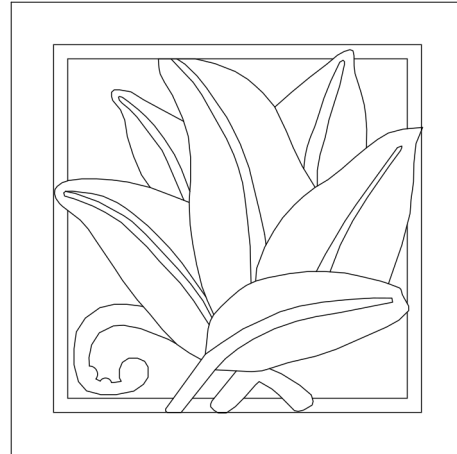

RE5001

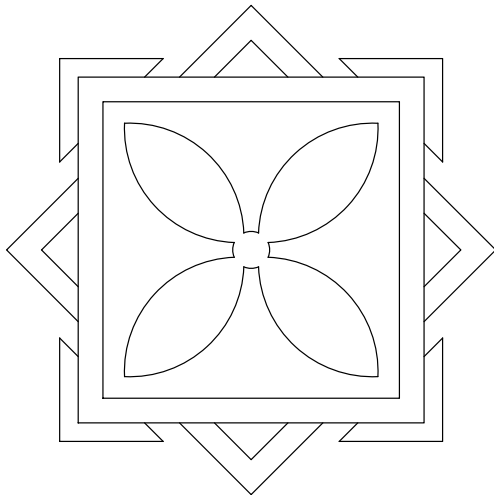

RE5002

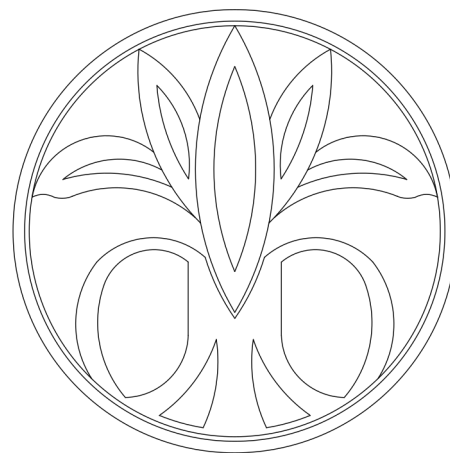

RE4000

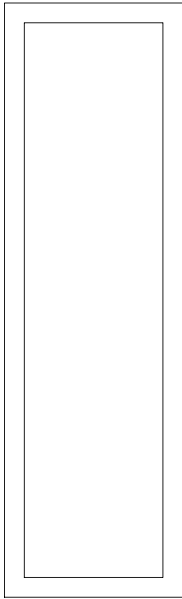

SH2000

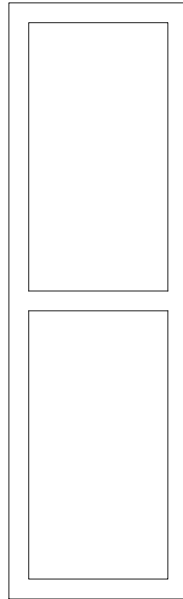

SH2001

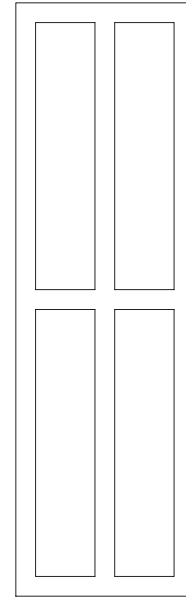

SH2002

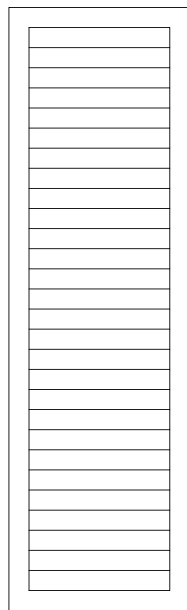

SH3000

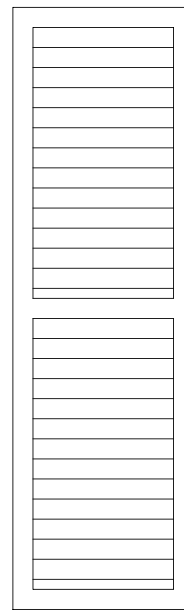

SH3001

Shutters

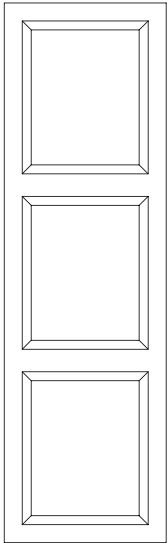

SH5000

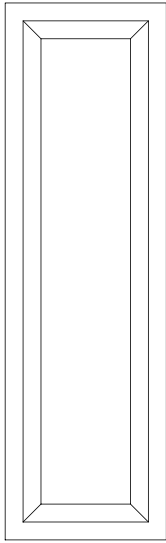

SH5001

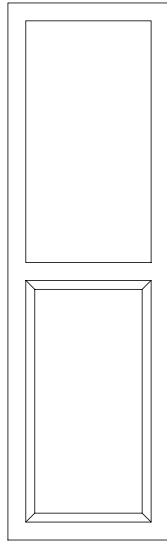

SH5002

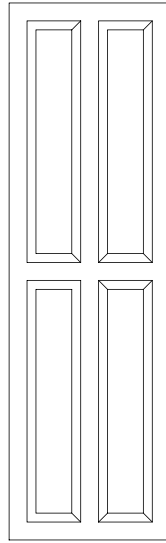

SH5003

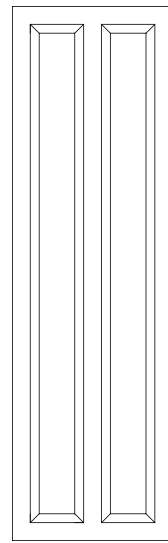

SH5004

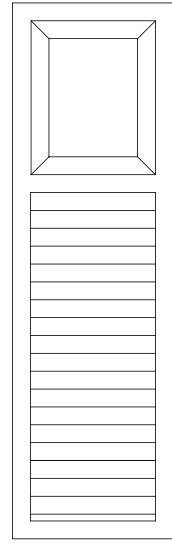

SH3002

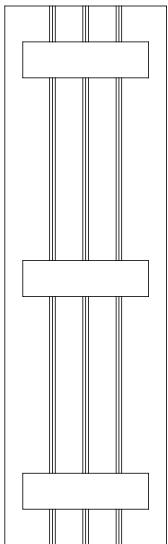

SH1000

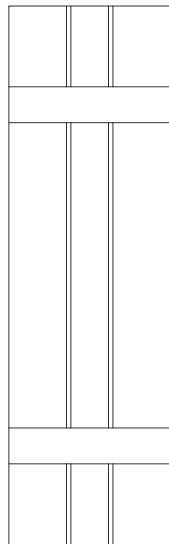

SH1001

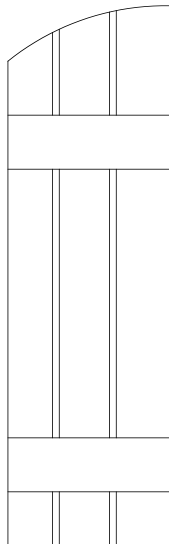

SH1002

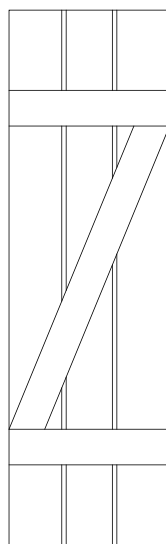

SH1003

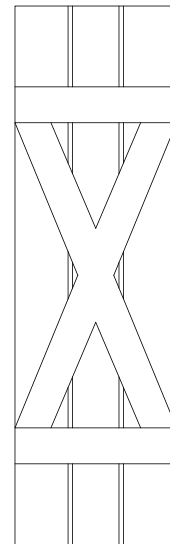

SH1004

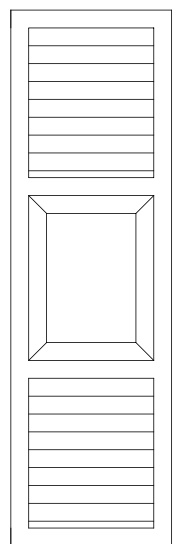

SH3003

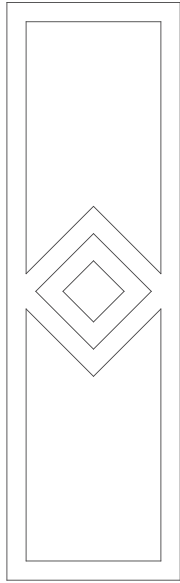

SH4000

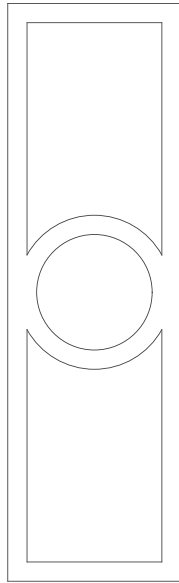

SH4001

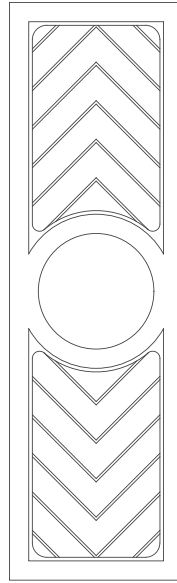

SH4002

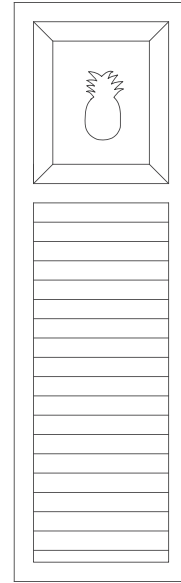

SH4003

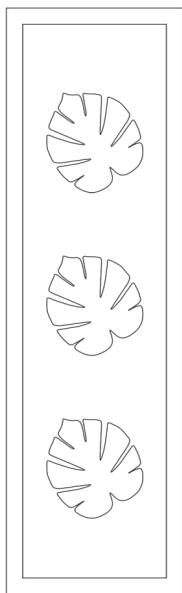

SH4004

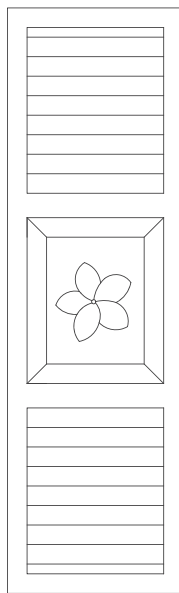

SH4005

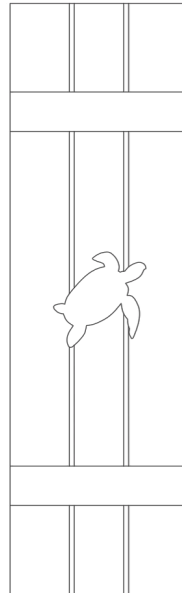

SH4006

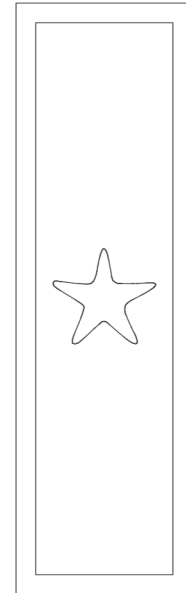

SH4007

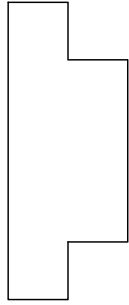

TR5000

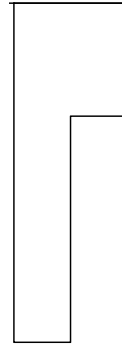

TR3005

Trim

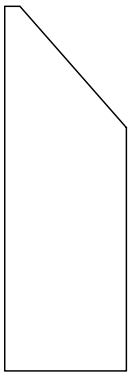

TR3030

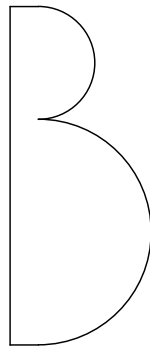

TR3024

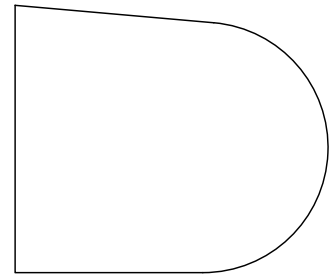

TR3019

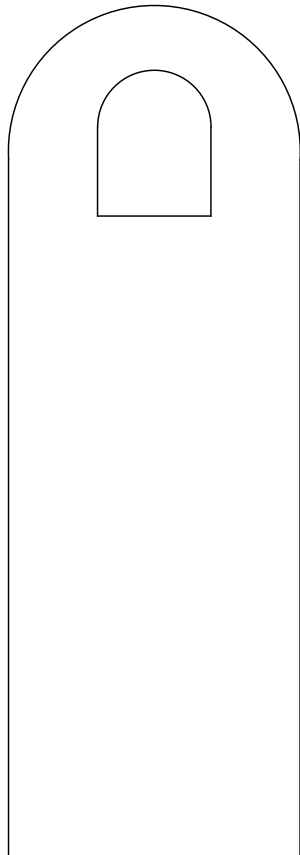

MB1000

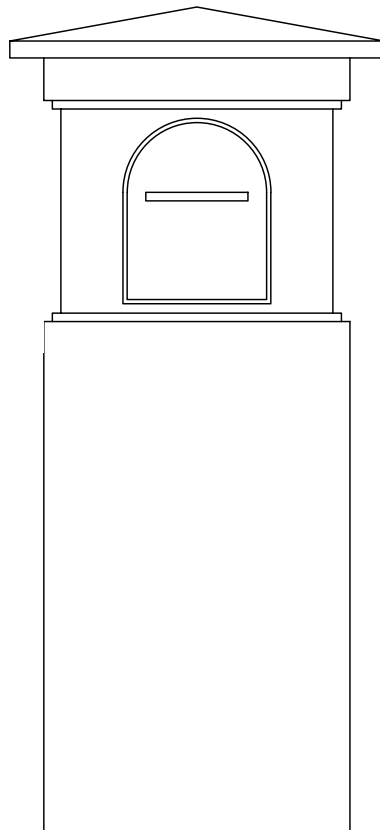

MB1001

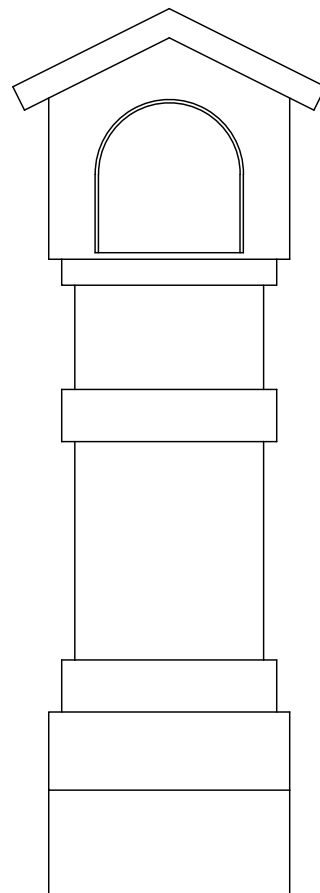

MB1002

Commercial Projects



Residential Projects

